

Numark[®]
Professional Disc Jockey Products

TT-1520

Direct-Drive Turntable

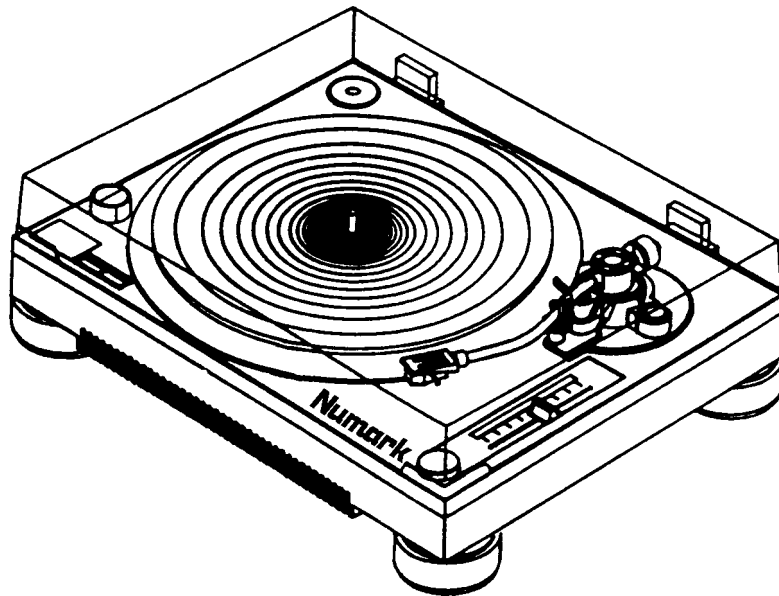

USER'S MANUAL

Safety Information



CAUTION
RISK OF ELECTRIC SHOCK
DO NOT OPEN



CAUTION: TO REDUCE THE RISK OF ELECTRIC SHOCK DO NOT REMOVE ANY COVER. NO USER-SERVICEABLE PARTS INSIDE. REFER SERVICING TO QUALIFIED SERVICE PERSONNEL ONLY.

The lightning flash with arrowhead symbol within the equilateral triangle is intended to alert the user to the presence of un-insulated "dangerous voltage" within the product's enclosure that may be of sufficient magnitude to constitute a risk of electric shock.

The exclamation point within the equilateral triangle is intended to alert the user to the presence of important operating and maintenance (servicing) instructions in the literature accompanying this appliance.

CAUTION

FOR USA & CANADIAN MODELS ONLY
TO PREVENT ELECTRIC SHOCK DO NOT USE THIS (POLARIZED) PLUG WITH AN EXTENSION CORD, RECEPTACLE OR OTHER OUTLET UNLESS THE BLADES CAN BE FULLY INSERTED TO PREVENT BLADE EXPOSURE.

SAFETY INSTRUCTIONS

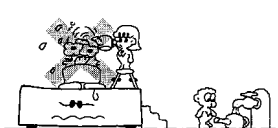
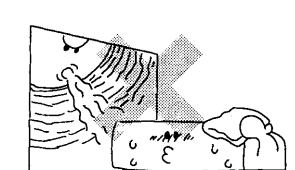
1. Read Instructions - All the safety and operating instructions should be read before this product is connected and used.
2. Retain Instructions - The safety and operating instructions should be kept for future reference.
3. Heed Warnings - All warnings on this product and in these operating instructions should be followed.
4. Follow Instructions - All operating and other instructions should be followed.
5. Water and Moisture - This product should be kept away from direct contact with liquids. 
6. Heat - Avoid placing this product to close to any high heat sources such as radiators.
7. Ventilation - The appliance should be situated so that its location or position does not interfere with its proper ventilation. For example, the appliance should not be situated on a bed, sofa, rug, or similar surface that may block the ventilation opening; or, placed in a built-installation, such as bookcase or cabinet that may impede the flow of air through the ventilation openings. 

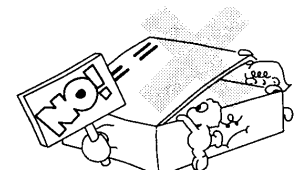
8. Power Sources - This product should be connected to a power supply only of the type described in these operating instructions, or as marked on the unit.
9. Power Cord Protection - Power supply cords should be routed so that they are not likely to be walked upon or pinched by items placed on or against them. When removing the cord from a power outlet be sure to remove it by holding the plug attachment and not by pulling on the cord. 
10. Object and Liquid Entry - Take care that objects do not fall into and that liquids are not spilled into the inside of the mixer.
11. Cleaning - The appliance should be cleaned only as recommended by the manufacturer.
12. Non-use Periods - The power cord of the appliance should be unplugged from the outlet when left unused for long periods of time.
13. Damage Requiring Service - Only qualified personnel should service this product. If you have any questions about service please contact Numark at the number(s) shown on the back cover of this manual. 
14. Grounding or Polarization - Precautions should be taken so that the grounding or polarization means built into the CD player is not defeated.
15. Internal/External Voltage Selectors - Internal or external voltage selector switches, if any, should only be reset and re-equipped with a proper plug for alternative voltage by a qualified service technician. Do not attempt to alter this yourself.

WARNING: To reduce the risk of fire or electrical shock, do not expose this appliance to rain or moisture. Electrical equipment should NEVER be kept or stored in damp environments.

SERVICE INSTRUCTIONS

- Disconnect power cord before servicing
- Replace critical components  only with factory parts or recommended equivalents
- For AC line powered units - Before returning repaired unit to user, use an ohmmeter to measure from both AC plug blades to all exposed metallic parts. The resistance should be no more than 100,000ohms.

Numark® TT-1520

PROFESSIONAL DIRECT-DRIVE TURNTABLE

CONGRATULATIONS!

You have just purchased the Numark TT1520 Professional Direct Drive Turntable. This unit has been design to provide years of reliable operation in an easy to use design. Thank you for purchasing a Numark Product and enjoy the mix.....

TABLE OF CONTENTS

Safety Information Product Registration	Page 2
Introduction	Page 3
Diagram and Parts Description	Page 4
Assembly	Page 4
Operating Instructions	Page 7
Specifications	Page 7
Warranty and Service	Page 8

Contents of this package

1. Main Unit	1
2. Turntable platter	1
3. Turntable mat	1
4. Dust cover	1
5. 45-rpm adapter	1
6. Counterweight	1
7. Headshell (cartridge attached on certain models)	1
8. Operating instructions	1
9. Registration Card	1

Product Registration

Please record the serial number of your unit as shown on the back of the chassis as well as the name of the dealer from whom you purchased the unit. Retain this information and your original purchase receipt for your records. Please return the enclosed warranty card to register your unit with us.

MODEL: _____
SERIAL NUMBER: _____

PURCHASED FROM: _____
DATE OF PURCHASE: _____

Numark - The Leader in DJ Technology

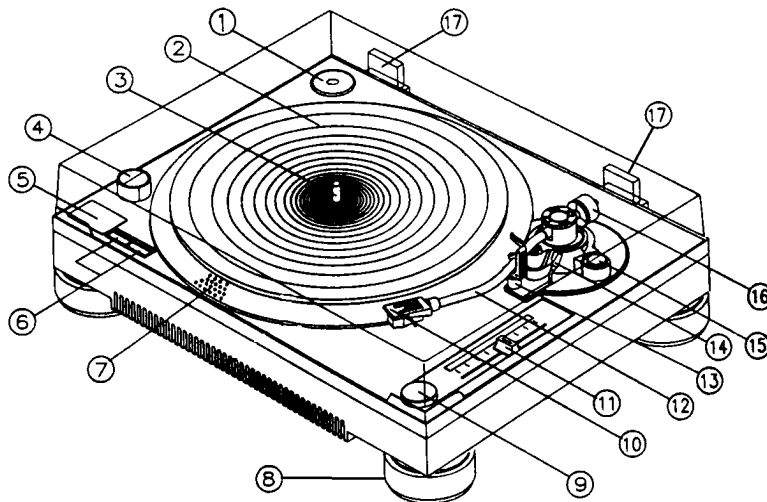

PARTS DESCRIPTION

- | | |
|-------------------------|--------------------------|
| 1. 45-rpm Adapter | 10. Headshell |
| 2. Anti-static slip mat | 11. Pitch Control Slider |
| 3. Center Spindle | 12. Tonearm |
| 4. Stroboscope | 13. Arm Rest |
| 5. Start/Stop Button | 14. Cueing Lever |
| 6. Speed Select Button | 15. Anti-skating Knob |
| 7. Strobe Dots | 16. Counterweight |
| 8. Adjustable Feet | 17. Hinge For Dust Cover |
| 9. Power Button | |

ASSEMBLY

1. Remove the main unit with the packing from the box and take off the packing material.
DO NOT DISCARD ANY PACKING MATERIAL. The headshell, counterweight, and other parts are contained within the packing material.
2. Set the 45-rpm adapter on the main unit.
3. Set the voltage selector switch to the 110-127 or 220-240V position according to the voltage of power supply. (This unit has been preset for 110-127V AC).

4. Insert the turntable platter onto the center spindle.

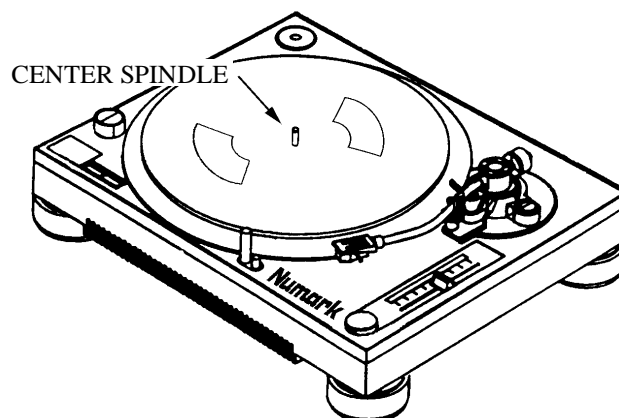

5. Set the turntable mat on the platter.
6. Installing the cartridge: *When installing a cartridge, refer to the operating instructions of that cartridge. During installation, attach the stylus protector to guard the stylus tip from damage.*

If you have purchased a unit with the cartridge included, then that cartridge is already installed on the headshell (You may skip to line 8).

- a. Connect the lead wires to the cartridge terminals. The terminals of most cartridges are color coded. Connect each lead wire to the terminal of the same color.

White (L+)	Left channel+
Blue (L-)	Left channel
Red (R+)	Right channel+
Green (R-)	Right channel

- b. Install the cartridge to the headshell and tighten it with screws provided with the cartridge.

7. Insert the headshell into the front end of the tonearm, then turn the locking nut clockwise with the head shell firmly held horizontally.

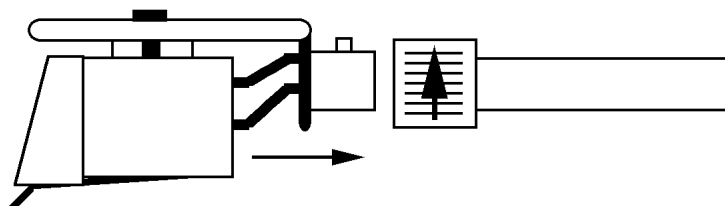

8. Slide counterweight onto the rear of the tonearm. Twist it lightly and it will screw onto the rear shaft of the tonearm.

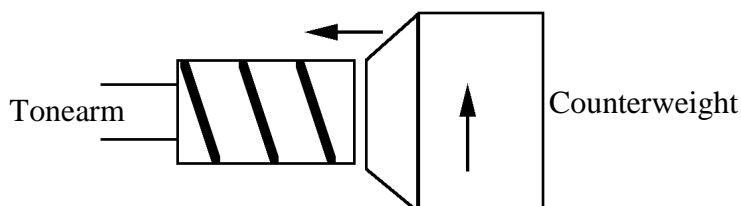

9. Adjustment of horizontal zero (O) balance with stylus pressure and anti-skating :

- a. Remove the stylus protector. Do not touch the stylus tip during the adjustment.
- b. Set the cueing lever to the lower position so it does not effect tone arm height.
- c. Release the arm clamp and lift the tonearm from the armrest so it moves freely.
- d. Rotate the counterweight until the tonearm is approximately balanced horizontally (floats freely).

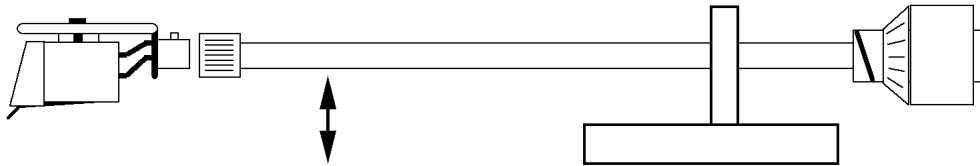

- e. Refasten the tonearm with the arm clamp.
- f. Hold the counterweight stationary with one hand and rotate only the stylus-pressure ring to bring the number "O" of the ring into alignment with the center line on the tonearm rear shaft.
- g. Rotate the counterweight with scale ring clockwise to the correct stylus pressure following the manufacturer's recommendation.
- h. Set the anti-skating control knob to the same value as the stylus pressure unless your manufacturer specifies otherwise

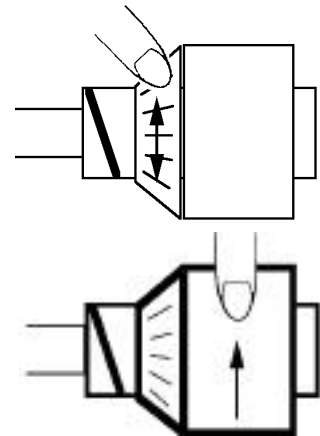

- 10. Install the dust cover to the main unit. This lid is not designed for continual removal. If you need to remove the lid press both release tabs at the same time.

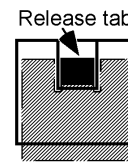

CONNECTIONS

- 1. Connect the power cord to the power outlet.
- 2. Connect the unit's output terminals from the rear of the unit to the PHONO jack of your DJ mixer or home amplifier/receiver.

Output terminals	Phono input of mixer
L (White) ----->	L Channel
R (Red) ----->	R Channel
GND (Spade) ----->	GND

Notes: *Be sure to connect the ground terminal firmly to the amplifier or receiver. If this connection is not loose, a power source "HUM" may result.*

OPERATING INSTRUCTIONS

1. Push the power button to turn on the power. The speed indicator and the strobe-illuminator will light up.
2. Place a record on the turntable mat. When playing a 45rpm record with a large center hole, place the 45-rpm adapter on the center spindle.
3. Set the rotation speed (33/45) to match the record.
4. Remove the stylus protector and release the arm clamp.
5. Set the cueing lever to the up position.
6. Press the Start/Stop button. The turntable platter will start to rotate.
7. Move the tonearm over the desired groove.
8. Set the cueing lever to the down position. The tonearm will descend slowly onto the record and play begins.
9. To suspend play, lift tone arm with cueing lever.
10. When play is finished, raise the cueing lever, move the tonearm to the armrest, and secure the tonearm with the arm clamp.
11. Press the Start/Stop button to stop the platter rotating, push the power button to turn off the power.

PITCH ADJUSTMENT

The pitch control is variable in a range of +/-10%. During play, observe the strobe dots. If the strobe dots appear to the right, the pitch is slower than the rated speed. If flow to the left, the pitch is faster than the rated speed. If the strobe dots appear stationary, which means the platter is in normal turntable speed, move the pitch control slider up or down to adjust the speed.

PLACEMENT

- Do not place the unit in a location where it will be exposed to direct sun light or near a heating appliance.
- Do not place the unit in a location where there is high humidity or a lot of dust.
- Cartridge may pick up slight sound pressure or vibrations of the speakers coming along the floor or through the air resulting in howling. Find a location, which is very stable and free of vibration.
- The legs have functions for adjusting the height of the unit itself. Adjust the legs to stabilize the main body horizontally.

MAINTENANCE

- Clean the stylus periodically with a soft brush to prevent the accumulation of dust.
- When the sound becomes distorted or noisy, check the stylus. If worn out, replace it with a new one.
- From time to time, the dust cover and turntable cabinet should be wiped with a soft, dry cloth. Any volatile materials as alcohol, thinner, benzene, etc., may remove the paint or damage the luster, should not be used.

SPECIFICATIONS

Turntable section

Type	2-speed, full manual
Driving method	Direct Drive
Motor	8pole,2phase, brushless DC motor
Turntable platter	Aluminum diecast 330mm dia.
Turntable speed	33-1/3 and 45 rpm
Starting torque	More than 600g-cm
Wow and flutter	Less than 0.20%
S/N ratio	55dB (DIN-B)

Tonearm section

Type	Universal s-shaped tubular arm
Effective length	220mm

General

Power supply	AC110-127V/220-240V,50/60Hz
Power consumption	20 Watts
Dimension (WxDxH)	450 x 350 x 148 mm 17 3/4" x 13 3/4" x 5 7/8"
Weight	7.5 Kgs 16 lbs

Specifications and design may be changed without notice for improvement

Numark- The Leader in DJ Technology

Numark®

Professional Disc Jockey Products

LIMITED PRODUCT WARRANTY

What is covered and for how long?

1. NUMARK INDUSTRIES LCC ("NUMARK") warrants to the original purchaser that NUMARK'S DJ mixers and amplifiers are free from defects in material and workmanship under normal use and service for the period commencing upon the date of purchase from an authorized NUMARK dealer and continuing for the following period of time after that date for (2) Years. The warranty is extended to (3) Years with the completion of the warranty card provided that the warranty card is completed and returned within (30) days from the date of purchase. All other NUMARK products are warranted for (1) Year including but not limited to CD players, CD Mix Stations, turntables, preamplifiers, beatkeepers, equalizers, microphones, headphones, and all other accessories.

What is not covered? This Limited Warranty is conditioned upon proper use of the product by the purchaser.

2. This Limited Warranty does not cover: (a) defects or damage resulting from accident, misuse, abuse, neglect, unusual physical or electrical stress, modification of any part of the product, or cosmetic damage; (b) equipment that has the serial number removed or made illegible; (c) all plastic surfaces and other externally exposed parts that are scratched or damaged due to normal use; (d) defects or damage from improper testing, operation, maintenance, installation, adjustment, or service of the mixers; (e) crossfaders.
3. What are NUMARK'S obligations? During the applicable warranty period, NUMARK will repair or replace, at NUMARK'S sole discretion, without charge to the purchaser, any defective component part of the mixer. To obtain service under this Limited Warranty, purchaser must first contact NUMARK and obtain a return authorization number ("RA#"). Purchaser must then return the mixer to NUMARK in an adequate container for shipping, accompanied by purchaser's sales receipt or comparable proof of sale showing the date of purchase, the serial number of the product, and the seller's name and address. To obtain an RA# and assistance on where to return the mixer, contact NUMARK customer service at 401-295 9000. Upon receipt, NUMARK will repair or replace the defective products. NUMARK may, at NUMARK'S sole discretion, use rebuilt, reconditioned, or new parts or components when repairing any product or replace a product with a rebuilt, reconditioned or new product. Repaired mixers will be warranted for a period equal to the remainder of the original Limited Warranty on the original mixer or for (90) days, whichever is longer. All replaced parts, components, boards and equipment become the property of NUMARK. If NUMARK determines that any mixer is not covered by this Limited Warranty, purchaser must pay all parts, shipping, and labor charges for the repair or return of such mixer.
4. What are the limits on NUMARK'S liabilities? THE WARRANTIES GIVEN IN THIS LIMITED WARRANTY, TOGETHER WITH ANY IMPLIED WARRANTIES COVERING NUMARK MIXERS, INCLUDING WITHOUT LIMITATION ANY WARRANTIES OF MERCHANTABILITY OR FITNESS FOR A PARTICULAR PURPOSE, ARE LIMITED TO THE DURATION OF THIS LIMITED WARRANTY. EXCEPT TO THE EXTENT PROHIBITED BY APPLICABLE LAW, NUMARK SHALL NOT BE LIABLE FOR ANY SPECIAL, INCIDENTAL, CONSEQUENTIAL, INDIRECT OR SIMILAR DAMAGES, LOSS OF PROFITS, DAMAGES TO PURCHASER'S PROPERTY, OR INJURY TO PURCHASER OR OTHERS ARISING OUT OF THE USE, MISUSE OR INABILITY TO USE ANY NUMARK MIXER, BREACH OF WARRANTY, OR NEGLIGENCE, INCLUDING BUT NOT LIMITED TO NUMARK'S OWN NEGLIGENCE, EVEN IF NUMARK OR ITS AGENT HAS BEEN ADVISED OF SUCH DAMAGES, OR FOR ANY CLAIM BROUGHT AGAINST PURCHASER BY ANY OTHER PARTY. THIS LIMITED WARRANTY IS THE COMPLETE WARRANTY FOR NUMARK'S MIXERS, AND IS GIVEN IN LIEU OF ALL OTHER EXPRESS WARRANTIES. THIS LIMITED WARRANTY SHALL NOT EXTEND TO ANYONE OTHER THAN THE ORIGINAL PURCHASER OF THIS PRODUCT AND STATES PURCHASER'S EXCLUSIVE REMEDY. IF ANY PORTION OF THIS LIMITED WARRANTY IS ILLEGAL OR UNENFORCEABLE BY REASON OF ANY LAW, SUCH PARTIAL ILLEGALITY OR UNENFORCEABILITY SHALL NOT AFFECT THE ENFORCEABILITY OF THE REMAINDER OF THIS LIMITED WARRANTY WHICH PURCHASER ACKNOWLEDGES IS AND WILL ALWAYS BE CONSTRUED TO BE LIMITED BY ITS TERMS OR AS LIMITED AS THE LAW PERMITS.
5. This Limited Warranty allocates risk of product failure between purchaser and NUMARK, and NUMARK'S product pricing reflects this allocation of risk and the limitations of liability contained in this Limited Warranty. The agents, employees, distributors, and dealers of NUMARK are not authorized to make modifications to this Limited Warranty, or make additional warranties binding on NUMARK. Accordingly, additional statements such as dealer advertising or presentation, whether oral or written, do not constitute warranties by NUMARK and should not be relied upon.
6. How does state law apply to this warranty? SOME STATES DO NOT ALLOW THE EXCLUSION OR LIMITATIONS OF INCIDENTAL OR CONSEQUENTIAL DAMAGES OR HOW LONG AN IMPLIED WARRANTY LASTS, SO THE ABOVE LIMITATIONS OR EXCLUSIONS MAY NOT APPLY TO PURCHASER.
7. This Limited Warranty gives you specific legal rights. You may also have other rights, which vary from one jurisdiction to another.

RETURN INFORMATION

- a) A Return Authorization number must be obtained from Numark through the address or phone numbers below.
- b) A copy of the original sales receipt must also be included for the equipment to be repaired under warranty.
- c) The faulty equipment must be packed in its original packaging.
- d) One additional outer layer of packaging must be included to ensure product safety. Failure to do so may inadequately protect the equipment in transit and, therefore, jeopardize the customer's warranty.
- e) Numark will not accept COD shipments and no call tags will be issued for merchandise return.
- f) Numark will not return repaired merchandise to customers by priority service, unless by written request at the customer's cost. Requests must be submitted in writing with merchandise returned.
- g) The defective Numark equipment should be sent, FREIGHT PREPAID with Return Authorization number clearly printed on the outer packaging and original sales receipt enclosed to:

Numark INDUSTRIES
Attention: Service Department
11 Helmsman Avenue
North Kingstown, RI 02852 USA

Phone: +1 (401) 295-9000
Fax: +1 (401) 295-5200
Web: www.numark.com