

Numark[®]

Professional Disc Jockey Products

DM3001X DJ MIXER



Owner's Manual

Safety Information



CAUTION
RISK OF ELECTRIC SHOCK
DO NOT OPEN



CAUTION: TO REDUCE THE RISK OF ELECTRIC SHOCK DO NOT REMOVE ANY COVER. NO USER-SERVICEABLE PARTS INSIDE. REFER SERVICING TO QUALIFIED SERVICE PERSONNEL ONLY.

The lightning flash with arrowhead symbol within the equilateral triangle is intended to alert the user to the presence of un-insulated "dangerous voltage" within the product's enclosure that may be of sufficient magnitude to constitute a risk of electric shock.

The exclamation point within the equilateral triangle is intended to alert the user to the presence of important operating and maintenance (servicing) instructions in the literature accompanying this appliance.

CAUTION

FOR USA & CANADIAN MODELS ONLY
TO PREVENT ELECTRIC SHOCK DO NOT USE THIS (POLARIZED) PLUG WITH AN EXTENSION CORD, RECEPTACLE OR OTHER OUTLET UNLESS THE BLADES CAN BE FULLY INSERTED TO PREVENT BLADE EXPOSURE.

SAFETY INSTRUCTIONS

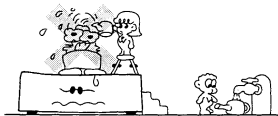
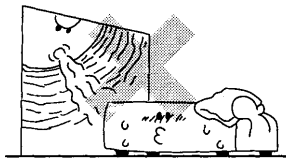
- a) Read Instructions - All the safety and operating instructions should be read before this product is connected and used.
- b) Retain Instructions - The safety and operating instructions should be kept for future reference.
- c) Heed Warnings - All warnings on this product and in these operating instructions should be followed.
- d) Follow Instructions - All operating and other instructions should be followed.
- e) Water and Moisture - This product should be kept away from direct contact with liquids. 
- f) Heat - Avoid placing this product too close to any high heat sources such as radiators.
- g) Ventilation - The appliance should be situated so that its location or position does not interfere with its proper ventilation. For example, the appliance should not be situated on a bed, sofa, rug, or similar surface that may block the ventilation opening; or, placed in a built-in installation, such as bookcase or cabinet that may impede the flow of air through the ventilation openings. 

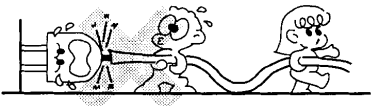
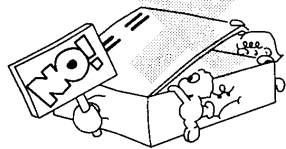
- h) Power Sources - This product should be connected to a power supply only of the type described in these operating instructions, or as marked on the unit.
- i) Power Cord Protection - Power supply cords should be routed so that they are not likely to be walked upon or pinched by items placed on or against them. When removing the cord from a power outlet be sure to remove it by holding the plug attachment and not by pulling on the cord. 
- j) Object and Liquid Entry - Take care that objects do not fall into and that liquids are not spilled into the inside of the mixer.
- k) Cleaning - The appliance should be cleaned only as recommended by the manufacturer.
- l) Non-use Periods - The power cord of the appliance should be unplugged from the outlet when left unused for long periods of time.
- m) Damage Requiring Service - Only qualified personnel should service this product. If you have any questions about service please contact Numark at the number(s) shown on the back cover of this manual. 
- n) Grounding or Polarization - Precautions should be taken so that the grounding or polarization means built into the CD player is not defeated.
- o) Internal/External Voltage Selectors - Internal or external voltage selector switches, if any, should only be reset and re-equipped with a proper plug for alternative voltage by a qualified service technician. Do not attempt to alter this yourself.

WARNING: To reduce the risk of fire or electrical shock, do not expose this appliance to rain or moisture. Electrical equipment should NEVER be kept or stored in damp environments.

SERVICE INSTRUCTIONS

- Disconnect power cord before servicing
- Replace critical components  only with factory parts or recommended equivalents
- For AC line powered units - Before returning repaired unit to user, use an ohmmeter to measure from both AC plug blades to all exposed metallic parts. The resistance should be no more than 100,000ohms.

VERY IMPORTANT**Please read this entire manual before connecting this unit to your system**

For optimum performance:

- The crossfader is a user replaceable item and subject to wear. Excessive force can wear out the fader quickly. This is not a warranted item.
- Never use spray cleaners on the slide controls. Residues cause excessive dirt build-up and this will void your warranty. In normal use slide controls can last for many years. If they malfunction (usually because of a dirty or dusty environment) consult a professional technician.
- Always make sure that AC power is OFF while making any connections.
- Use appropriate cables throughout your system. Do not use excessively long cables (i.e. over 50ft/14m) Be sure plugs and jacks are tightly mated. Loose connections can cause hum, noise or intermittents that could easily damage your speakers. Make the input and output connections with readily available low-capacitance stereo cables. Quality cable makes a big difference in audio fidelity and punch. See your Numark dealer or an electronics or audio specialist store if you are not sure which cables to get.
- Never attempt to make any adjustments or repairs other than those described in this manual. Take the unit to your dealer or to an authorized Numark Service Center.
- ALWAYS remember: "TURN AMPS ON LAST AND OFF FIRST". Begin with master faders or volume controls on minimum and the amplifier gain/input control(s) down. Wait 8 to 10 seconds before turning up the volume. This prevents transients which may cause severe speaker damage.
- Use restraint when operating controls. Try to move them slowly. Rapid adjustments could damage speakers due to amplifier clipping.
- Avoid amplifier "clipping" at all costs: this occurs when the red LEDs (usually on the front panel of most professional power amplifiers) start flashing. "Clipping" is when the power amplifier is distorting and working beyond it's limits. Amplifier distortion is THE major cause of speaker failure.
- To prevent fire or shock hazard, do not expose the unit to rain or moisture. Never place cans of beer, soda, glasses of water or anything wet on top of the unit!

Product Registration

Please record the serial number of your unit as shown on the back of the chassis as well as the name of the dealer from whom you purchased the unit. Retain this information and your original purchase receipt for your records. Please return the enclosed warranty card to register your unit with us.

MODEL: _____

PURCHASED FROM: _____

SERIAL NUMBER: _____

DATE OF PURCHASE: _____

Numark® DM3001X

PROFESSIONAL DJ MIXER

CONGRATULATIONS!

You have purchased the DM3001X Stereo Mixer by **Numark**. This mixer was developed by DJs for you combining requested features in an easy to understand layout. Using the latest in circuit design technology and our history of award winning development experience you can expect years of reliable service from this product.

Careful attention to detail was provided in this unit. The DM3001X even has smooth edges to ensure your fingers don't get caught up in the mix. We hope you enjoy the **Numark** experience.

Thank you for purchasing NUMARK products!

FEATURES:

CROSSFADER

- Crossfader Reverse (Hamster) Toggle with off position
- Variable Slope Control
- Channel Assign selectors
- Transform Buttons
- Treble Middle and Bass KILL toggles

MONITORING

- Two Bar 12-Segment Display graph for Stereo Master output
- Split/Blend Cue selection
- Push Button Cueing
- PFL Cue Meter
- Headphone Jacks for Both 1/4" and 1/8" Headphone Plugs

INPUTS

- 5-line, 3-phono, 1-mic input
- Front Panel 1/4" Mic input with Bass, and Treble controls
- Rotary Bass, Middle & Treble -32dB "CUT" and +10dB "Boost"
- PFL cue monitoring with send out for sampling
- PFL Gain Adjust

OUTPUTS

- Monitor/Zone Level Control
- Record Output
- PFL sampling output

TABLE OF CONTENTS

Safety Measures	2
Important Information	3
Registration	3
Introduction	4
Description of the Features	6
Quick Setup Diagram	9
Block Diagram	10
Specifications	11
Warranty	12

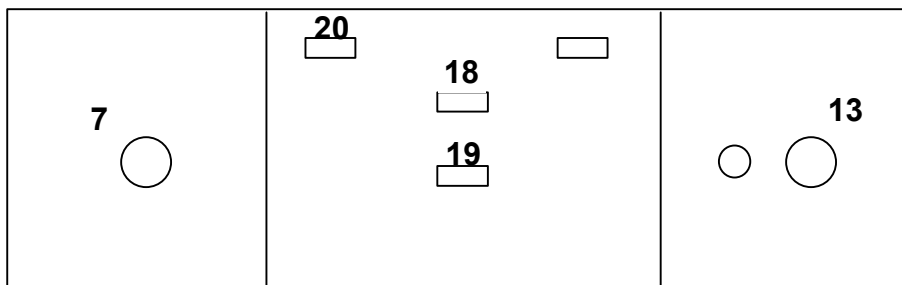
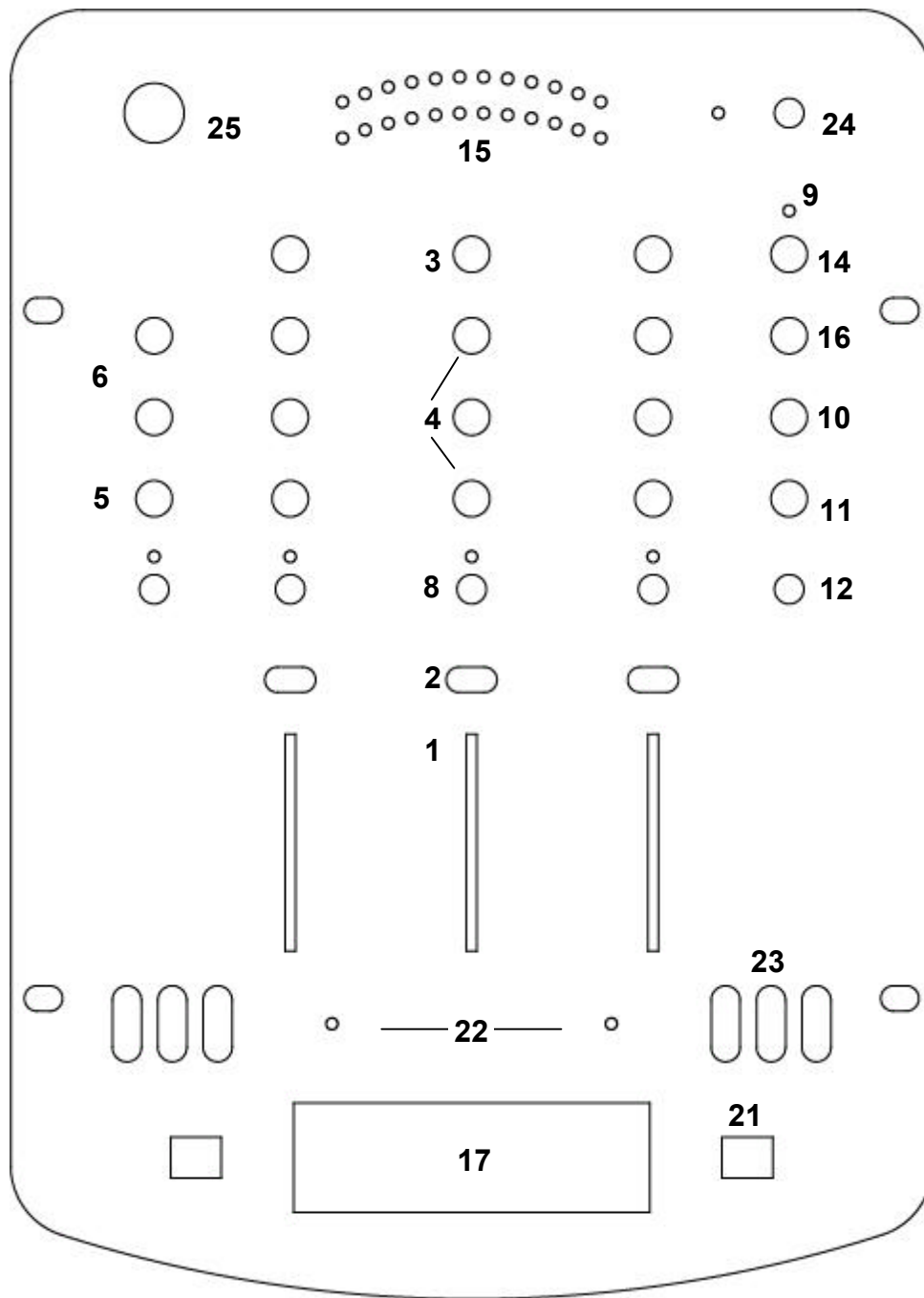

MIXER FEATURES

INPUTS

1. **Input faders** - control individual source levels in the mix.
2. **Input Toggle Switch (Transform)** - selects which source will be live to that channel based on what you have connected to the rear panel input section. By removing the face panel the switch can be rotated into any of eight positions.
3. **Pre-fader Gain Control** – adjusts the pre-fader volume for cleaner sound. Use this in conjunction with the PFL Meter to adjust the audio to an optimum level.
4. **Channel EQ** – adjusts the Treble, Middle, and Bass frequencies respectively of the channel audio. Full rotation to the left creates a “CUT” effect eliminating most of the sound from that frequency area.

MICROPHONE

5. **Mic Gain Controls** – controls the **DJ Mic** volume for the **Neutrik™** “Combo” connector on the front panel.
6. **Treble and Bass Controls** – for fine-tuning the tone of your voice on both mics through the sound system. The controls are detented for setting tone “flat”. For best results, use a dynamic cardioid microphone.
7. **¼” input connector** - allows connection of a ¼” microphone jack directly into the mixer.

HEADPHONE CUEING

8. **Channel PFL/Cue Assign** - are used to route Pre Fader Level (PFL) channel audio to the **Monitor Section**. The channel faders do not control the **Cue** volume.
9. **PFL Meter Indicator** – lights when PFL audio is not being sent to the LED meter. When the LED is off the channel audio is sent to the meter display for PFL matching. Accurately match channel levels with the Pre-fader gain controls before mixing them together. The idea is to properly match PFL inputs, not the input with the stereo output meter!
10. **Headphone Mix** - controls the mix of PFL and PGM signals to your headphones. When the slider is moved to the left, all you will hear is the cue source. When the slider is all the way to the right, you will hear what is playing through the master output. By blending, beats can be matched exactly and segues can be smooth when a song is cued.
11. **Headphone Level** – adjusts cue volume.
12. **Split/Blend Cue** – controls how PFL and Program audio are sent to your headphones. In **split** mode, the PFL audio can be heard in your left ear and PGM audio can be heard in your right ear. In **blend** mode, both PFL and PGM can be heard in both ears.
13. **Headphone output** – for your ¼” or 1/8” headphones.

OUTPUTS

14. **Master Fader** – controls the overall output level.
15. **Stereo Auto Peak Hold Level Indicator**- quickly and accurately tracks level of audio output. The red LEDs show output overload. **When using as a master output meter**, set the crossover, equalizer and power amp inputs to avoid distortion at each step in the audio chain. Will also act as PFL meter when PFL/Cue buttons are pressed.
16. **Zone Output** - controls output zone level for monitors or extra sound system.

CROSSFADER

17. **Crossfader** - achieves clean segues between the two input channels selected by the Crossfader Assign.
18. **Crossfader Slope** – determines how quickly the audio from the opposing side of the crossfader activates. A tight curve (right position) turns on the opposing audio signal with very little crossfader movement. A loose curve (left position) makes very long and smooth segues in transition.
19. **Hamster switch with Off position** – reverses the direction of the crossfader. In the center position the crossfader is deactivated.
20. **Crossfader Assign** – channels 1 or 2 can be assigned to the left. Channels 2 and 3 can be assigned to the right. If for example channels 1 and 3 were selected then “Hard left” selects Channel 1 and “Hard right” selects Channel 3. With the crossfader centered, both assigned channels are live. Use the crossfader for fast and seamless segues from one selected channel to the other.
Note: If channel 2 is selected on both sides, the crossfader will turn off channel 2 in the left position and turn it on in the right position
Note: *The crossfader is user replaceable in case of failure. Simply unscrew the two large screws that hold it in place, lift it out and disconnect its cable. Re-attach the new crossfader and screw the mounting plate back onto the unit - you're back in business!*
21. **Beat Lights** – Indicate when strong bass beats are present to allow more accurate beat mixes.
22. **Push Button transforms** – By pressing these button the crossfader channel will respond as determined by the transform assign
23. **KILL switches** - By moving these toggle down or up the marked frequency area will be removed. For instance if BASS is pressed the bass beat will be removed, Highs might remove cymbals, and middle might remove vocals.

OTHER ITEMS

24. **Power Switch** – Activates mixer power. Always turn on input devices first, the mixer second, and amplifiers last!
25. **Light Connector** – for attaching a 12V BNC style gooseneck light.

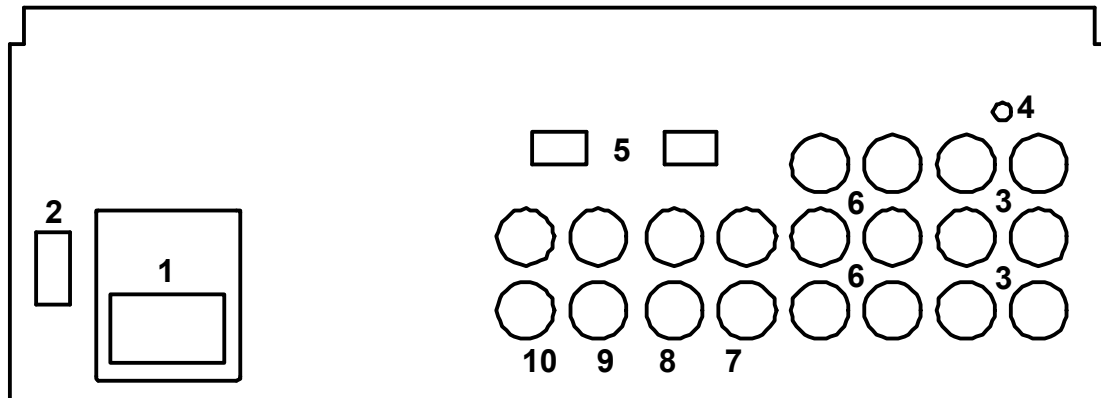
REAR PANEL FEATURES

1. **Power Input** - to plug your power plug in before switching on power. See safety precautions on page 3 for proper treatment of power.
2. **Voltage Selector** – Set this to the appropriate power for your location. If unsure ask your authorized dealer.
3. **Phono Inputs** – plug your turntables in here.
4. **Ground lug** - use these connections with your turntables' grounding cable to avoid signal hum.
5. **Stereo/Phono Selector** – select the appropriate position for your input device. With phono selected the input signal is fed directly to the DM3001X phono pre-amplifiers so use this input only for turntables. Line level sources will overload the sensitive phono pre-amps. Switch this over to the AUX position for line devices such as CD players and Tape decks.
6. **Line Inputs** - to connect stereo audio from HiFi VCRs, cassette and reel-to-reel tape decks, DAT machines, CD players, laser discs, tuners, even synthesizers or other mixing consoles.
NOTE: Plug mono audio sources into both Left and Right inputs using a "Y" cable connector.
7. **Channel PFL Send** – this output contains the PFL signal you hear in your headphones. The send should be plugged into your sampler and the signal returned through one of your inputs.
8. **Record Outputs** – Plug in your tape deck to record your mix. Audio level is determined by the channel inputs.
9. **Zone Outputs** – Plug in a sound system for another room or booth monitor.
10. **Unbalanced Main Outputs** – program output controlled by the Master fader knob.

QUICK SETUP DIAGRAM

Study this setup diagram. Make sure all faders are at "zero" and all devices are off. First, connect all input sources and processors. Next, connect your microphone and monitor headphones. Finally, connect the stereo outputs to the power amplifier(s) and/or audio receivers such as tape decks. Plug your mixer into AC power. Now you are ready to switch everything on. **IMPORTANT:** Always switch on your audio input sources such as turntables or CD players first, then your mixer, and finally any amplifiers. When turning off, always reverse this operation by turning off amplifiers, then your mixer, and then input devices.

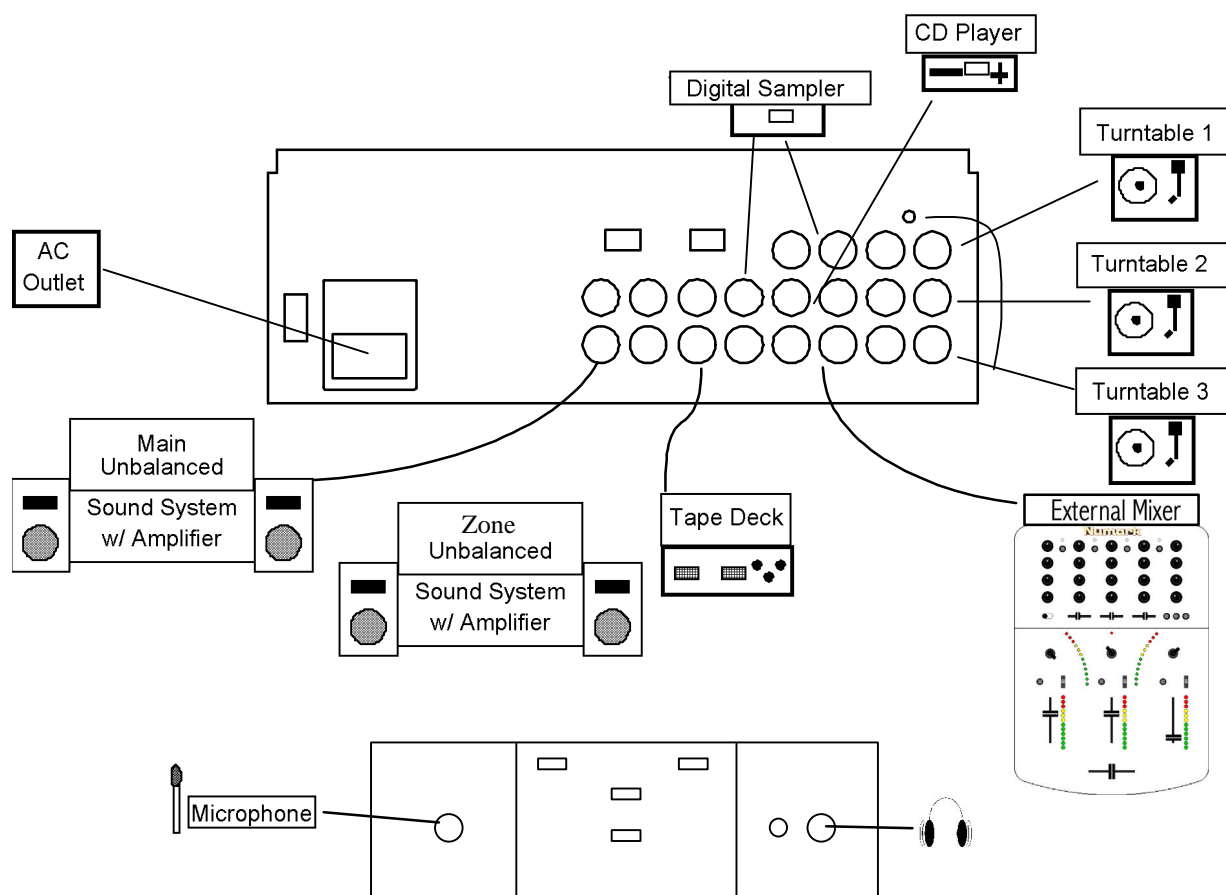

SPECIFICATIONS

Inputs:

Line: 10K ohm input impedance
83mV rms sensitivity for 1.22V output

Mic: 600 ohm input impedance unbalanced
1mV rms sensitivity for 1.22V output
65mV rms max input

Phono: 47Kohm input impedance
1.3mV rms sensitivity @ 1KHz for 1.22V output

Outputs:

Line: 9V rms max

Headphone: 0.5W into 47ohm

Distortion: less than 0.01%

Signal to Noise Ratio: (maximum output) JIS-A weighted

Line: Better than 92dB

Mic: Better than 82dB

Phono: Better than 85dB

Frequency response:

Line: 20Hz-20KHz +/-0.5dB

Mic: 20Hz-15KHz +/-0.5dB

Phono: +/-1dB except for controlled attenuation of -3dB
@ 20Hz to reduce rumble and feedback

Channel equalizer:

Bass: +12/-32dB @40Hz

Middle: +12/-32dB @1.35KHz

Treble: +10/-28dB @15KHz

Channel Kill :

Bass: Better than 80dB at 40Hz

Middle: Better than 80dB at 1KHz

Treble: Better than 80dB at 15KHz

Power consumption:

16.7 Watt typical

21.2 Watt with full headphone output

Dimensions: 254mm(W)x 355mm(D)x 90mm(H)

Weight: 3.5 kgs

Numark - *The Leader in DJ Technology*

Numark®

Professional Disc Jockey Products

LIMITED PRODUCT WARRANTY

What is covered and for how long?

1. NUMARK INDUSTRIES LCC ("NUMARK") warrants to the original purchaser that NUMARK products; including but not limited to DJ mixer, amplifiers, CD players, CD Mix Stations, turntables, preamplifiers, beatkeepers, equalizers, microphones, headphones, cartridges, and all other accessories; are to be free from defects in material and workmanship under normal use and service for the period commencing upon the date of purchase from an authorized NUMARK dealer for a period of (1) Year.

What is not covered? This Limited Warranty is conditioned upon proper use of the product by the purchaser.

2. This Limited Warranty does not cover: (a) defects or damage resulting from accident, misuse, abuse, neglect, unusual physical or electrical stress, modification of any part of the product, or cosmetic damage; (b) equipment that has the serial number removed or made illegible; (c) all plastic surfaces and other externally exposed parts that are scratched or damaged due to normal use; (d) defects or damage from improper testing, operation, maintenance, installation, adjustment, or service of the mixer; (e) crossfaders.
3. What are NUMARK'S obligations? During the applicable warranty period, NUMARK will repair or replace, at NUMARK'S sole discretion, without charge to the purchaser, any defective component part of the mixer. To obtain service under this Limited Warranty, purchaser must first contact NUMARK and obtain a return authorization number ("RA#"). Purchaser must then return the mixer to NUMARK in an adequate container for shipping, accompanied by purchaser's sales receipt or comparable proof of sale showing the date of purchase, the serial number of the product, and the seller's name and address. To obtain an RA# and assistance on where to return the mixer, contact NUMARK customer service at 401-295 9000. Upon receipt, NUMARK will repair or replace the defective products. NUMARK may, at NUMARK'S sole discretion, use rebuilt, reconditioned, or new parts or components when repairing any product or replace a product with a rebuilt, reconditioned or new product. Repaired mixer will be warranted for a period equal to the remainder of the original Limited Warranty on the original mixer or for (90) days, whichever is longer. All replaced parts, components, boards and equipment become the property of NUMARK. If NUMARK determines that any mixer is not covered by this Limited Warranty, purchaser must pay all parts, shipping, and labor charges for the repair or return of such mixer.
4. What are the limits on NUMARK'S liabilities? THE WARRANTIES GIVEN IN THIS LIMITED WARRANTY, TOGETHER WITH ANY IMPLIED WARRANTIES COVERING NUMARK MIXER, INCLUDING WITHOUT LIMITATION ANY WARRANTIES OF MERCHANTABILITY OR FITNESS FOR A PARTICULAR PURPOSE, ARE LIMITED TO THE DURATION OF THIS LIMITED WARRANTY. EXCEPT TO THE EXTENT PROHIBITED BY APPLICABLE LAW, NUMARK SHALL NOT BE LIABLE FOR ANY SPECIAL, INCIDENTAL, CONSEQUENTIAL, INDIRECT OR SIMILAR DAMAGES, LOSS OF PROFITS, DAMAGES TO PURCHASER'S PROPERTY, OR INJURY TO PURCHASER OR OTHERS ARISING OUT OF THE USE, MISUSE OR INABILITY TO USE ANY NUMARK MIXER, BREACH OF WARRANTY, OR NEGLIGENCE, INCLUDING BUT NOT LIMITED TO NUMARK'S OWN NEGLIGENCE, EVEN IF NUMARK OR ITS AGENT HAS BEEN ADVISED OF SUCH DAMAGES, OR FOR ANY CLAIM BROUGHT AGAINST PURCHASER BY ANY OTHER PARTY. THIS LIMITED WARRANTY IS THE COMPLETE WARRANTY FOR NUMARK'S MIXER, AND IS GIVEN IN LIEU OF ALL OTHER EXPRESS WARRANTIES. THIS LIMITED WARRANTY SHALL NOT EXTEND TO ANYONE OTHER THAN THE ORIGINAL PURCHASER OF THIS PRODUCT AND STATES PURCHASER'S EXCLUSIVE REMEDY. IF ANY PORTION OF THIS LIMITED WARRANTY IS ILLEGAL OR UNENFORCEABLE BY REASON OF ANY LAW, SUCH PARTIAL ILLEGALITY OR UNENFORCEABILITY SHALL NOT AFFECT THE ENFORCEABILITY OF THE REMAINDER OF THIS LIMITED WARRANTY WHICH PURCHASER ACKNOWLEDGES IS AND WILL ALWAYS BE CONSTRUED TO BE LIMITED BY ITS TERMS OR AS LIMITED AS THE LAW PERMITS.
5. This Limited Warranty allocates risk of product failure between purchaser and NUMARK, and NUMARK'S product pricing reflects this allocation of risk and the limitations of liability contained in this Limited Warranty. The agents, employees, distributors, and dealers of NUMARK are not authorized to make modifications to this Limited Warranty, or make additional warranties binding on NUMARK. Accordingly, additional statements such as dealer advertising or presentation, whether oral or written, do not constitute warranties by NUMARK and should not be relied upon.
6. How does state law apply to this warranty? SOME STATES DO NOT ALLOW THE EXCLUSION OR LIMITATIONS OF INCIDENTAL OR CONSEQUENTIAL DAMAGES OR HOW LONG AN IMPLIED WARRANTY LASTS, SO THE ABOVE LIMITATIONS OR EXCLUSIONS MAY NOT APPLY TO PURCHASER.
7. This Limited Warranty gives you specific legal rights. You may also have other rights, which vary from one jurisdiction to another.

RETURN INFORMATION

- a) A Return Authorization number must be obtained from Numark through the address or phone numbers below.
- b) A copy of the original sales receipt must also be included for the equipment to be repaired under warranty.
- c) The faulty equipment must be packed in its original packaging.
- d) One additional outer layer of packaging must be included to ensure product safety. Failure to do so may inadequately protect the equipment in transit and, therefore, jeopardize the customer's warranty.
- e) Numark will not accept COD shipments and no call tags will be issued for merchandise return.
- f) Numark will not return repaired merchandise to customers by priority service, unless by written request at the customer's cost. Requests must be submitted in writing with merchandise returned.
- g) The defective Numark equipment should be sent, FREIGHT PREPAID with Return Authorization number clearly printed on the outer packaging and original sales receipt enclosed to:

Numark INDUSTRIES
Attention: Service Department
11 Helmsman Avenue
North Kingstown, RI 02852 USA

Phone: +1 (401) 295-9000
Fax:: +1 (401) 295-5200
Web: www.numark.com