

Numark NS6 serato  DJ

Control Map

Installation & Setup

1. Download and install Serato DJ from serato.com/dj/downloads.
2. NS6 requires drivers for both Mac and Windows. Go to numark.com/ns6 and see the **Downloads** section of the page. If the NS6 driver for your operating system is not the latest, please download and install the latest driver.
3. After installing the driver, connect your NS6 to your computer's USB port, and power on NS6.
4. Open Serato DJ.

Note: NS6 does not require a Serato DJ license purchase. When you first open Serato DJ, a license panel appears on the right hand side, and the software will be in Library View Mode.

Simply check the **Do Not Show Again** box in the lower right corner, and then click **License** to hide this panel. Serato DJ will remember these settings.

To then change the view mode:

- Press NS6's VIEW button.
- Use the drop-down menu in the upper left corner in Serato DJ.

Using NS6 with Serato DJ

Looping

Serato DJ lets you create up to 8 loops per track with the choice between Manual or Auto Loops. You can choose whether you have 4 loops (and 4 Cue Points) or 8 loops (and 8 Cue Points) shown on the screen.

To switch between Manual Loop Mode and Auto Loop Mode, press NS6's MODE button on the desired Deck.

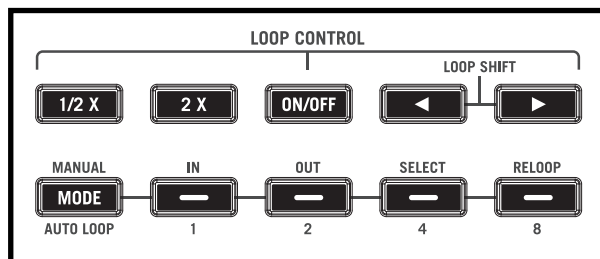



NS6 loop controls

NS6's controls perform the following looping functions in Serato DJ, depending on the mode:

NS6 Controls	Manual Loop Mode	Auto Loop Mode
1/2 X	Halve loop length	Halve loop length
2 X	Double loop length	Double loop length
ON / OFF	Activate/deactivate loop	Activate/deactivate loop
◀ (LOOP SHIFT LEFT)	Shift loop left	Shift loop left
▶ (LOOP SHIFT RIGHT)	Shift loop right	Shift loop right
MODE (MANUAL / AUTO LOOP)	Switch between Manual Loop and Auto Loop Modes	
IN / 1	Loop inactive: Set Loop In Point Loop active: Adjust Loop In Point	Activate/deactivate 1-bar Auto Loop
OUT / 2	Loop inactive: Set Loop Out Point Loop active: Adjust Loop Out Point	Activate/deactivate 2-bar Auto Loop
SELECT / 4	Scroll through saved loops	Activate/deactivate 4-bar Auto Loop
RELOOP / 8	Reloop (activates and jumps to loop)	Activate/deactivate 8-bar Auto Loop
SHIFT + IN / 1	Trigger 16th-note Loop Roll	No function
SHIFT + OUT / 2	Trigger 8th-note Loop Roll	No function
SHIFT + SELECT / 4	Trigger quarter-note Loop Roll	No function
SHIFT + RELOOP / 8	Trigger half-note Loop Roll	No function

Notes:

- We recommend using NS6's PLATTERS to adjust the Loop In and Loop Out Points of a Manual Loop.
- You can save a loop to the next available "loop slot" in the software. To do this, click the  button in the Manual/Auto loop tab, or click  on an available loop slot. Your loops will be saved to the file and will be recalled the next time you load it, even if the file has been moved or renamed.

Effects

The DJ effects in Serato DJ are powered by iZotope®.

To open the effects panel, click the **FX** tab in Serato DJ.



Serato DJ FX tab

To assign an effect:

- **To a specific Deck:** Press the FX SEND A or B button above the desired channel/Deck on your NS6. The corresponding Deck number (1, 2, 3, or 4) will be selected in the **Deck Assign** area in Serato DJ.



NS6 FX SEND A/B buttons (Decks)

Note: By default, Effect A is assigned to Deck 1, and Effect B is assigned to Deck 2.

- **To the Master Output:** Press the FX SEND A or B button under the MASTER VOLUME knob on your NS6. **M** will be selected in the **Deck Assign** area in Serato DJ.

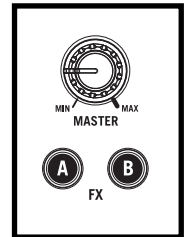

NS6 FX SEND A/B buttons (Master)

To adjust the effect parameters:

- Use the software controls in Serato DJ.
- Use the FX MIX fader, FX PARAM knob, or either of these in conjunction with the SHIFT button.

NS6 Controls	Effects Function
FX A or B	Activate/deactivate Effect A or B
FX SEND A or B	Activate/deactivate effect on specific Deck
FX MIX Fader	Parameter 1 (Dial 1)
SHIFT + FX A or B	Parameter 2 (Button 2)
FX PARAM	Parameter 2 (Dial 2)
SHIFT + FX PARAM	Parameter 3 (Dial 3)
FX SELECT (tapped)	Tap Tempo (Beat Multiplier)
FX SELECT (pressed and held for 2 seconds)	Reset effect BPM (automatically sync with Deck's BPM)
SHIFT + FX SELECT	Effect scroll & select

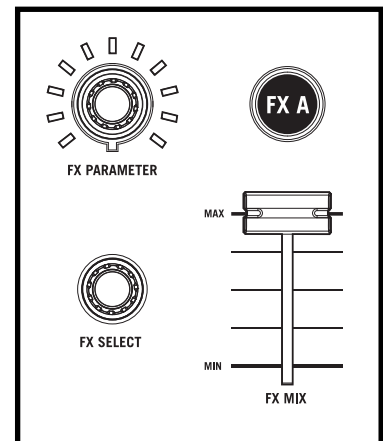

NS6 effects controls

Tool Tips

To enable Tool Tips, click the  icon between the **MIDI** and **Setup** buttons in the upper right corner of the screen. Tool Tips provide a handy way to learn the various features of Serato DJ.

To view Tool Tips, move the mouse over a feature on the screen. A context-sensitive Tool Tip will appear, showing more information about that feature.

To view a list of all keyboard shortcuts, hold the mouse over the  button with Tool Tips turned on.

Using NS6 with Serato Video

Serato Video is a plugin for Serato software that lets you play and mix video files and use effects and fader transitions. You can use your NS6, an additional MIDI controller, or your mouse and keyboard to control Serato Video.

For more information, visit serato.com/video.

Information and Support

Serato DJ

- For more information, refer to the Serato DJ Software Manual, or visit serato.com/dj.
- For support, visit serato.com/dj/support or contact support@serato.com.

Numark NS6

- For more information, visit numark.com/ns6 and download the relevant manual or file from the **Documents** section of the page.
- For support, go to numark.com/support.